

Fabricated Connections

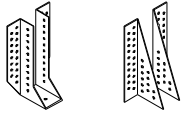

Metal Connectors - Joist Hangers

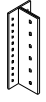

Metal Connectors - Beam Connectors

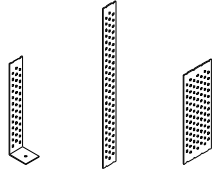

Metal Connectors - Perforated Plates / Straps



Two-sided shear connectors

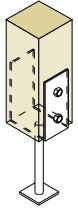

Prefabricated Connector - Tube Post Support

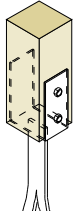

Prefabricated Connector - Post Support U Bracket

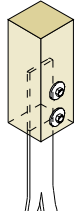

Prefabricated Connector - Rag Strap Post Support

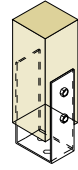

Prefabricated Connector - U Bracket

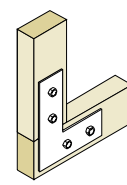

Prefabricated Connector - L Bracket

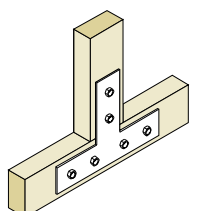

Prefabricated Connector - T Bracket

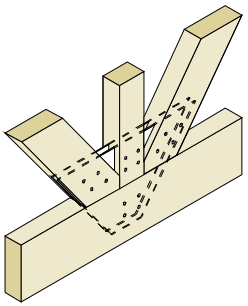

Truss Joint - Internal Metal Gusset Plate

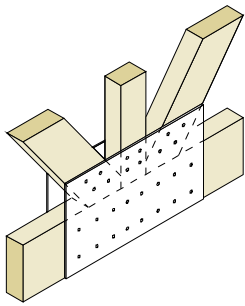

Truss Joint - Side Gusset Plates

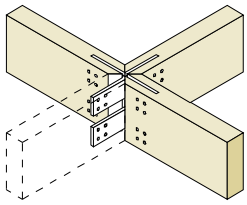

Beam-Grid - Welded Joint Plate

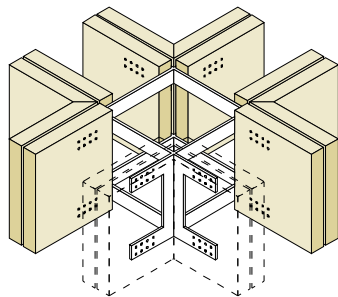

Deep Beam-Grid - Welded Joint Plate

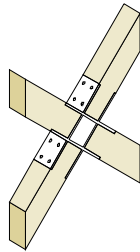

Thorncross Chapel Custom Joint - Roof Truss Joint - Screwed

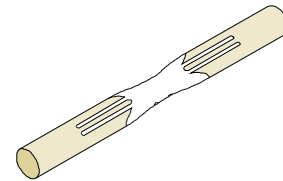

IBM Travelling Pavilion Glued Custom Joint - Cast Aluminium Fingered Connector

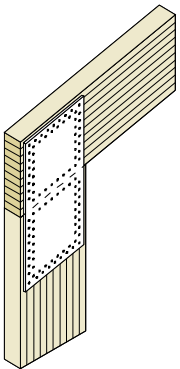

Knee Joint - Nailed Side Steel Plates

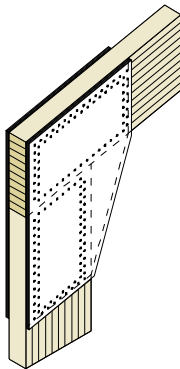

Knee Joint - Nailed Plywood Gussets

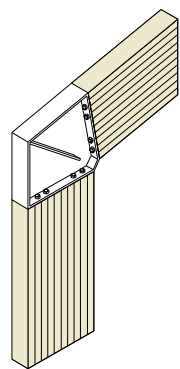

Knee Joint - Epoxied Rods & Steel Connector

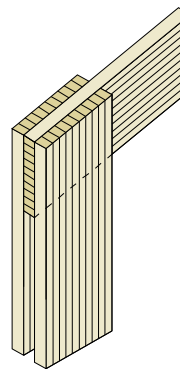

Knee Joint - Glued Cross Lap

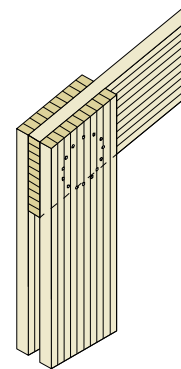

Knee Joint - Mechanically Fastened Cross Lap with Pressed-in Metal Dowels

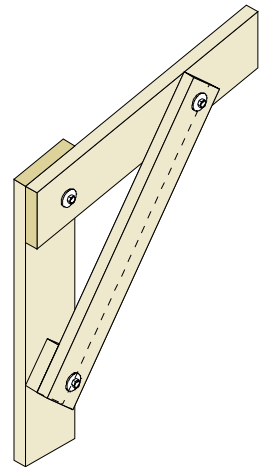

Knee Joint - Bolt Fixed Triangulated Brace

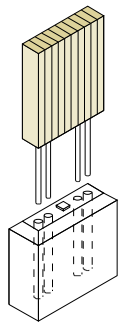

Foot Joint - Epoxied Bars

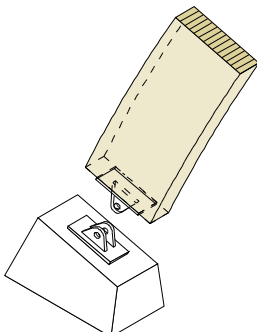

Foot Joint - Exposed Pin Joint

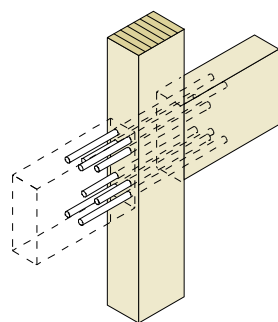

Beam-Column Joint - Epoxied Bars

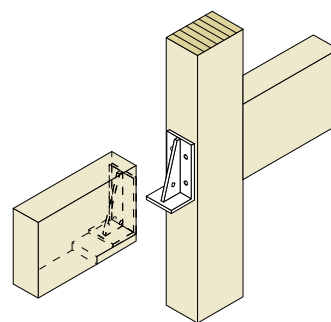

Beam-Column Joint - Steel Hanger with Central Web